

PUNTAS DE ATORNILLAR



PUNTAS INTERCAMBIABLES DE ATORNILLAR

Plus



25mm
LONG.
TOTAL
(L₁)



Puntas de atornillar

Rosa

PHILIPS



€ x Punta		2 Uds		5 Uds		50 Uds		100 Uds	
	L ₁ mm		€		€		€		€
Ph 0	25	Ph0-2	2,02	Ph0-5	1,74	Ph0-50	1,47	Ph0-100	1,43
Ph 1	25	Ph1-2	0,74	Ph1-5	0,58	Ph1-50	0,50	Ph1-100	0,46
Ph 2	25	Ph2-2	0,74	Ph2-5	0,58	Ph2-50	0,50	Ph2-100	0,46
Ph 3	25	Ph3-2	0,74	Ph3-5	0,58	Ph3-50	0,50	Ph3-100	0,46
Ph 4	25	Ph4-2	2,98	Ph4-5	2,62	Ph4-50	2,50	Ph4-100	-

POZIDRIV



€ x Punta		2 Uds		5 Uds		50 Uds		100 Uds	
	L ₁ mm		€		€		€		€
Pz 0	25	Pz0-2	2,02	Pz0-5	1,74	Pz0-50	1,47	Pz0-100	1,43
Pz 1	25	Pz1-2	0,74	Pz1-5	0,58	Pz1-50	0,50	Pz1-100	0,46
Pz 2	25	Pz2-2	0,74	Pz2-5	0,58	Pz2-50	0,50	Pz2-100	0,46
Pz 3	25	Pz3-2	0,74	Pz3-5	0,58	Pz3-50	0,50	Pz3-100	0,46
Pz 4	25	Pz4-2	2,74	Pz4-5	2,62	Pz4-50	2,50	Pz4-100	-

PHILIPS
REDUCIDA



€ x Punta		2 Uds		5 Uds		50 Uds		100 Uds	
	L ₁ mm		€		€		€		€
Ph 1R	25	Ph1R-2	2,36	Ph1R-5	2,02	Ph1R-50	1,88	Ph1R-100	-
Ph 2R	25	Ph2R-2	2,36	Ph2R-5	2,02	Ph2R-50	1,88	Ph2R-100	-
Ph 3R	25	Ph3R-2	2,36	Ph3R-5	2,02	Ph3R-50	1,88	Ph3R-100	-

POZIDRIV
REDUCIDA



€ x Punta		2 Uds		5 Uds		50 Uds		100 Uds	
	L ₁ mm		€		€		€		€
Pz 1R	25	Pz1R-2	2,36	Pz1R-5	2,02	Pz1R-50	1,88	Pz1R-100	-
Pz 2R	25	Pz2R-2	2,36	Pz2R-5	2,02	Pz2R-50	1,88	Pz2R-100	-
Pz 3R	25	Pz3R-2	2,36	Pz3R-5	2,02	Pz3R-50	1,88	Pz3R-100	-

PUNTAS INTERCAMBIABLES DE ATORNILLAR



25mm
LONG.
TOTAL
(L1)



Puntas de atornillar

Rosa

RANURA



€ x Punta		2 Uds		5 Uds		50 Uds		100 Uds	
	L1 mm		€		€		€		€
0,5X3,0	25	P0,5X3,0-2	1,36	P0,5X3,0-5	1,12	P0,5X3,0-50	1,07	P0,5X3,0-100	1,00
0,6X3,5	25	P0,6X3,5-2	1,36	P0,6X3,5-5	1,12	P0,6X3,5-50	1,07	P0,6X3,5-100	1,00
0,5X4,0	25	P0,5X4,0-2	1,36	P0,5X4,0-5	1,12	P0,5X4,0-50	1,07	P0,5X4,0-100	1,00
0,6X4,5	25	P0,6X4,5-2	1,36	P0,6X4,5-5	1,12	P0,6X4,5-50	1,07	P0,6X4,5-100	1,00
0,8X4,0	25	P0,8X4,0-2	1,36	P0,8X4,0-5	1,12	P0,8X4,0-50	1,07	P0,8X4,0-100	1,00
0,8X5,0	25	P0,8X5,0-2	1,36	P0,8X5,0-5	1,12	P0,8X5,0-50	1,07	P0,8X5,0-100	1,00
0,8X5,5	25	P0,8X5,5-2	1,36	P0,8X5,5-5	1,12	P0,8X5,5-50	1,07	P0,8X5,5-100	1,00
1,0X5,5	25	P1X5,5-2	1,36	P1X5,5-5	1,12	P1X5,5-50	1,07	P1X5,5-100	1,00
1,0X6,0	25	P1X6,0-2	1,36	P1X6,0-5	1,12	P1X6,0-50	1,07	P1X6,0-100	1,00
1,2X6,5	25	P1,2X6,5-2	1,36	P1,2X6,5-5	1,12	P1,2X6,5-50	1,07	P1,2X6,5-100	1,00
1,2X8,0	25	P1,2X8,0-2	1,36	P1,2X8,0-5	1,12	P1,2X8,0-50	1,07	P1,2X8,0-100	1,00

TORX

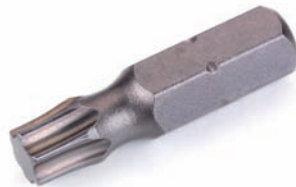

€ x Punta		2 Uds		5 Uds		50 Uds		100 Uds	
	L1 mm		€		€		€		€
T5	25	PT5-2	1,78	PT5-5	1,47	PT5-50	1,33	PT5-100	1,24
T6	25	PT6-2	1,78	PT6-5	1,47	PT6-50	1,33	PT6-100	1,24
T7	25	PT7-2	1,78	PT7-5	1,47	PT7-50	1,33	PT7-100	1,24
T8	25	PT8-2	1,78	PT8-5	1,47	PT8-50	1,33	PT8-100	1,24
T9	25	PT9-2	1,78	PT9-5	1,47	PT9-50	1,33	PT9-100	1,24
T10	25	PT10-2	1,62	PT10-5	1,07	PT10-50	1,00	PT10-100	0,95
T15	25	PT15-2	1,62	PT15-5	1,07	PT15-50	1,00	PT15-100	0,95
T20	25	PT20-2	1,62	PT20-5	1,07	PT20-50	1,00	PT20-100	0,95
T25	25	PT25-2	1,62	PT25-5	1,07	PT25-50	1,00	PT25-100	0,95
T27	25	PT27-2	1,62	PT27-5	1,07	PT27-50	1,00	PT27-100	0,95
T30	25	PT30-2	1,62	PT30-5	1,07	PT30-50	1,00	PT30-100	0,95
T40	25	PT40-2	1,62	PT40-5	1,07	PT40-50	1,00	PT40-100	0,95

TORX REDONDA



€ x Punta		2 Uds		5 Uds		50 Uds		100 Uds	
	L1 mm		€		€		€		€
TR10	25	PTR10-2	7,37	PTR10-5	7,18	PTR10-50	5,59	PTR10-100	5,45
TR15	25	PTR15-2	7,37	PTR15-5	7,18	PTR15-50	5,59	PTR15-100	5,45
TR20	25	PTR20-2	7,37	PTR20-5	7,18	PTR20-50	5,59	PTR20-100	5,45
TR25	25	PTR25-2	7,37	PTR25-5	7,18	PTR25-50	5,59	PTR25-100	5,45
TR30	25	PTR30-2	7,37	PTR30-5	7,18	PTR30-50	5,59	PTR30-100	5,45
TR40	25	PTR40-2	7,37	PTR40-5	7,18	PTR40-50	5,59	PTR40-100	5,45

CUADRADO ROBERTSON



€ x Punta		2 Uds		5 Uds		50 Uds		100 Uds	
	L1 mm		€		€		€		€
Nº1	25	PC1-2	2,74	PC1-5	2,59	PC1-50	2,50	PC1-100	2,45
Nº2	25	PC2-2	2,74	PC2-5	2,59	PC2-50	2,50	PC2-100	2,45
Nº3	25	PC3-2	2,74	PC3-5	2,59	PC3-50	2,50	PC3-100	2,45

PUNTAS INTERCAMBIABLES DE ATORNILLAR

Plus



25mm
LONG.
TOTAL
(L₁)



TORX DE
SEGURIDAD



€ x Punta		2 Uds		5 Uds		50 Uds		100 Uds	
	L ₁ mm		€		€		€		€
TS10	25	PTS10-2	2,69	PTS10-5	2,40	PTS10-50	2,26	PTS10-100	2,07
TS15	25	PTS15-2	2,69	PTS15-5	2,40	PTS15-50	2,26	PTS15-100	2,07
TS20	25	PTS20-2	2,69	PTS20-5	2,40	PTS20-50	2,26	PTS20-100	2,07
TS25	25	PTS25-2	2,69	PTS25-5	2,40	PTS25-50	2,26	PTS25-100	2,07
TS27	25	PTS27-2	2,69	PTS27-5	2,40	PTS27-50	2,26	PTS27-100	2,07
TS30	25	PTS30-2	2,69	PTS30-5	2,40	PTS30-50	2,26	PTS30-100	2,07
TS40	25	PTS40-2	2,69	PTS40-5	2,40	PTS40-50	2,26	PTS40-100	2,07

CABEZA
HEXAGONAL



€ x Punta		2 Uds		5 Uds		50 Uds		100 Uds	
	L ₁ mm		€		€		€		€
2 mm	25	PHX2-2	1,69	PHX2-5	1,62	PHX2-50	1,52	PHX2-100	1,43
2,5 mm	25	PHX2,5-2	1,69	PHX2,5-5	1,62	PHX2,5-50	1,52	PHX2,5-100	1,43
3 mm	25	PHX3-2	1,69	PHX3-5	1,62	PHX3-50	1,52	PHX3-100	1,43
4 mm	25	PHX4-2	1,69	PHX4-5	1,62	PHX4-50	1,52	PHX4-100	1,43
5 mm	25	PHX5-2	1,69	PHX5-5	1,62	PHX5-50	1,52	PHX5-100	1,43
6 mm	25	PHX6-2	1,69	PHX6-5	1,62	PHX6-50	1,52	PHX6-100	1,43
8 mm	25	PHX8-2	1,69	PHX8-5	1,62	PHX8-50	1,52	PHX8-100	1,43

TRI
WING



€ x Punta		2 Uds		5 Uds		50 Uds		100 Uds	
	L ₁ mm		€		€		€		€
Nº4	25	PTRW4-2	7,11	PTRW4-5	6,82	PTRW4-50	6,06	PTRW4-100	5,56
Nº5	25	PTRW5-2	7,11	PTRW5-5	6,82	PTRW5-50	6,06	PTRW5-100	5,56
Nº6	25	PTRW6-2	7,11	PTRW6-5	6,82	PTRW6-50	6,06	PTRW6-100	5,56
Nº8	25	PTRW8-2	7,11	PTRW8-5	6,82	PTRW8-50	6,06	PTRW8-100	5,56
Nº10	25	PTRW10-2	7,11	PTRW10-5	6,82	PTRW10-50	6,06	PTRW10-100	5,56

XZN



€ x Punta		2 Uds		5 Uds		50 Uds		100 Uds	
	L ₁ mm		€		€		€		€
Nº4	25	PXZN4-2	4,73	PXZN4-5	4,19	PXZN4-50	3,99	PXZN4-100	3,83
Nº5	25	PXZN5-2	4,73	PXZN5-5	4,19	PXZN5-50	3,99	PXZN5-100	3,83
Nº6	25	PXZN6-2	4,73	PXZN6-5	4,19	PXZN6-50	3,99	PXZN6-100	3,83
Nº8	25	PXZN8-2	7,11	PXZN8-5	6,56	PXZN8-50	6,44	PXZN8-100	6,21
Nº10	25	PXZN10-2	7,11	PXZN10-5	6,56	PXZN10-50	6,44	PXZN10-100	6,21

PUNTAS INTERCAMBIABLES DE ATORNILLAR

Plus



50mm
LONG.
TOTAL
(L₁)



Puntas de atornillar

Rosa

PHILIPS

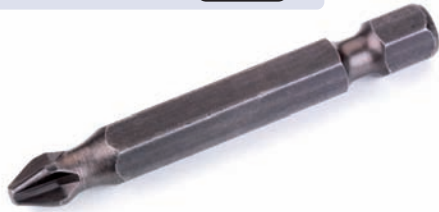

€ x Punta		2 Uds		5 Uds		50 Uds	
	L ₁ mm		€		€		€
Ph 1	50	Ph1X50-2	2,34	Ph1X50-5	2,19	Ph1X50-50	2,05
Ph 2	50	Ph2X50-2	2,34	Ph2X50-5	2,19	Ph2X50-50	2,05
Ph 3	50	Ph3X50-2	2,34	Ph3X50-5	2,19	Ph3X50-50	2,05
Ph 4	50	Ph4X50-2	-	Ph4X50-5	-	Ph4X50-50	-

POZIDRIV



€ x Punta		2 Uds		5 Uds		50 Uds	
	L ₁ mm		€		€		€
Pz 1	50	Pz1X50-2	2,34	Pz1X50-5	2,19	Pz1X50-50	2,05
Pz 2	50	Pz2X50-2	2,34	Pz2X50-5	2,19	Pz2X50-50	2,05
Pz 3	50	Pz3X50-2	2,34	Pz3X50-5	2,19	Pz3X50-50	2,05
Pz 4	50	Pz4X50-2	-	Pz4X50-5	-	Pz4X50-50	-

RANURA

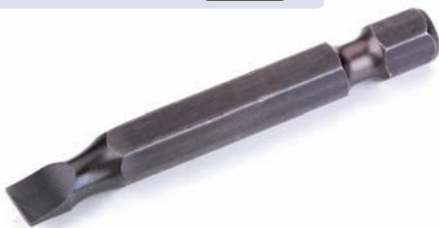

€ x Punta		2 Uds		5 Uds		50 Uds	
	L ₁ mm		€		€		€
0,5X4,0	50	P0,5X4,0X50-2	3,81	P0,5X4,0X50-5	3,71	P0,5X4,0X50-50	3,61
0,5X3,0	50	P0,5X3,0X50-2	3,81	P0,5X3,0X50-5	3,71	P0,5X3,0X50-50	3,61
0,6X3,5	50	P0,6X3,5X50-2	3,81	P0,6X3,5X50-5	3,71	P0,6X3,5X50-50	3,61
0,6X4,5	50	P0,6X4,5X50-2	3,81	P0,6X4,5X50-5	3,71	P0,6X4,5X50-50	3,61
0,8X4,0	50	P0,8X4,0X50-2	3,81	P0,8X4,0X50-5	3,71	P0,8X4,0X50-50	3,61
0,8X5,0	50	P0,8X5,0X50-2	3,81	P0,8X5,0X50-5	3,71	P0,8X5,0X50-50	3,61
0,8X5,5	50	P0,8X5,5X50-2	3,81	P0,8X5,5X50-5	3,71	P0,8X5,5X50-50	3,61
1X5,5	50	P1X5,5X50-2	3,81	P1X5,5X50-5	3,71	P1X5,5X50-50	3,61
1X6,0	50	P1X6,0X50-2	3,81	P1X6,0X50-5	3,71	P1X6,0X50-50	3,61
1,2X6,5	50	P1,2X6,5X50-2	3,81	P1,2X6,5X50-5	3,71	P1,2X6,5X50-50	3,61
1,2X8,0	50	P1,2X8,0X50-2	3,81	P1,2X8,0X50-5	3,71	P1,2X8,0X50-50	3,61

PUNTAS INTERCAMBIABLES DE ATORNILLAR

Plus



50mm
LONG.
TOTAL
(L₁)



Puntas de atornillar

Rosa

TORX



€ x Punta		2 Uds		5 Uds		50 Uds	
	L ₁ mm		€		€		€
T 5	50	PT5X50-2	4,78	PT5X50-5	4,64	PT5X50-50	4,57
T 6	50	PT6X50-2	4,78	PT6X50-5	4,64	PT6X50-50	4,57
T 7	50	PT7X50-2	4,78	PT7X50-5	4,64	PT7X50-50	4,57
T 8	50	PT8X50-2	4,78	PT8X50-5	4,64	PT8X50-50	4,57
T 9	50	PT9X50-2	4,78	PT9X50-5	4,64	PT9X50-50	4,57
T 10	50	PT10X50-2	3,69	PT10X50-5	3,59	PT10X50-50	3,52
T 15	50	PT15X50-2	3,69	PT15X50-5	3,59	PT15X50-50	3,52
T 20	50	PT20X50-2	3,69	PT20X50-5	3,59	PT20X50-50	3,52
T 25	50	PT25X50-2	3,69	PT25X50-5	3,59	PT25X50-50	3,52
T 27	50	PT27X50-2	3,69	PT27X50-5	3,59	PT27X50-50	3,52
T 30	50	PT30X50-2	3,69	PT30X50-5	3,59	PT30X50-50	3,52
T 40	50	PT40X50-2	3,69	PT40X50-5	3,59	PT40X50-50	3,52

CUADRADO
ROBERTSON



€ x Punta		2 Uds		5 Uds		50 Uds	
	L ₁ mm		€		€		€
Nº1	50	PC1X50-2	4,73	PC1X50-5	4,68	PC1X50-50	4,61
Nº2	50	PC2X50-2	4,73	PC2X50-5	4,68	PC2X50-50	4,61
Nº3	50	PC3X50-2	4,73	PC3X50-5	4,68	PC3X50-50	4,61

CABEZA
HEXAGONAL

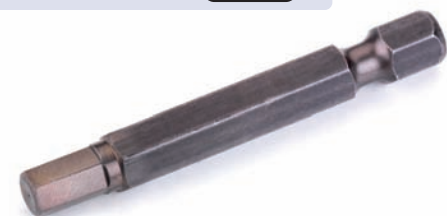

€ x Punta		2 Uds		5 Uds		50 Uds	
	L ₁ mm		€		€		€
2mm	50	PHX2X50-2	4,21	PHX2X50-5	4,14	PHX2X50-50	4,02
2,5mm	50	PHX2,5X50-2	4,21	PHX2,5X50-5	4,14	PHX2,5X50-50	4,02
3mm	50	PHX3X50-2	4,21	PHX3X50-5	4,14	PHX3X50-50	4,02
4mm	50	PHX4X50-2	4,21	PHX4X50-5	4,14	PHX4X50-50	4,02
5mm	50	PHX5X50-2	4,21	PHX5X50-5	4,14	PHX5X50-50	4,02
6mm	50	PHX6X50-2	4,21	PHX6X50-5	4,14	PHX6X50-50	4,02
8mm	50	PHX8X50-2	5,35	PHX8X50-5	5,30	PHX8X50-50	5,21

PUNTAS INTERCAMBIABLES DE ATORNILLAR



70mm
LONG.
TOTAL
(L₁)



PHILIPS



€ x Punta		2 Uds		5 Uds	
	L ₁ mm		€		€
Ph 1	70	Ph1X70-2	5,12	Ph1X70-5	4,92
Ph 2	70	Ph2X70-2	5,12	Ph2X70-5	4,92
Ph 3	70	Ph3X70-2	5,12	Ph3X70-5	4,92
Ph 4	70	Ph4X70-2	-	Ph4X70-5	-

POZIDRIV

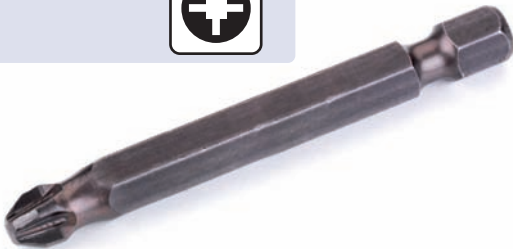

€ x Punta		2 Uds		5 Uds	
	L ₁ mm		€		€
Pz 1	70	Pz1X70-2	5,12	Pz1X70-5	4,92
Pz 2	70	Pz2X70-2	5,12	Pz2X70-5	4,92
Pz 3	70	Pz3X70-2	5,12	Pz3X70-5	4,92
Pz 4	70	Pz4X70-2	-	Pz4X70-5	-



90mm
LONG.
TOTAL
(L₁)



PHILIPS

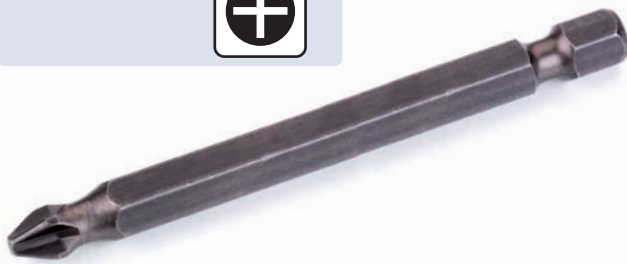

€ x Punta		2 Uds		5 Uds	
	L ₁ mm		€		€
Ph 1	90	Ph1X90-2	5,61	Ph1X90-5	5,42
Ph 2	90	Ph2X90-2	5,61	Ph2X90-5	5,42
Ph 3	90	Ph3X90-2	5,61	Ph3X90-5	5,42
Ph 4	90	Ph4X90-2	-	Ph4X90-5	-

POZIDRIV



€ x Punta		2 Uds		5 Uds	
	L ₁ mm		€		€
Pz 1	90	Pz1X90-2	5,61	Pz1X90-5	5,42
Pz 2	90	Pz2X90-2	5,61	Pz2X90-5	5,42
Pz 3	90	Pz3X90-2	5,61	Pz3X90-5	5,42
Pz 4	90	Pz4X90-2	-	Pz4X90-5	-

PUNTAS INTERCAMBIABLES DE ATORNILLAR

TiN



25mm
LONG.
TOTAL
(L₁)



PHILIPS



€ x Punta		2 Uds		5 Uds		50 Uds	
	L ₁ mm		€		€		€
Ph 1	25	Ph1T-2	1,64	Ph1T-5	1,38	Ph1T-50	1,21
Ph 2	25	Ph2T-2	1,64	Ph2T-5	1,38	Ph2T-50	1,21
Ph 3	25	Ph3T-2	1,64	Ph3T-5	1,38	Ph3T-50	1,21

POZIDRIV



€ x Punta		2 Uds		5 Uds		50 Uds	
	L ₁ mm		€		€		€
Pz 1	25	Pz1T-2	1,64	Pz1T-5	1,38	Pz1T-50	1,21
Pz 2	25	Pz2T-2	1,64	Pz2T-5	1,38	Pz2T-50	1,21
Pz 3	25	Pz3T-2	1,64	Pz3T-5	1,38	Pz3T-50	1,21

RANURA



€ x Punta		2 Uds		5 Uds		50 Uds	
	L ₁ mm		€		€		€
0,6X4,5	25	P0,6X4,5T-2	2,02	P0,6X4,5T-5	1,78	P0,6X4,5T-50	1,71
0,8X5,5	25	P0,8X5,5T-2	2,02	P0,8X5,5T-5	1,78	P0,8X5,5T-50	1,71
1X5,5	25	P1X5,5T-2	2,02	P1X5,5T-5	1,78	P1X5,5T-50	1,71
1,2X6,5	25	P1,2X6,5T-2	2,02	P1,2X6,5T-5	1,78	P1,2X6,5T-50	1,71

TORX



€ x Punta		2 Uds		5 Uds		50 Uds	
	L ₁ mm		€		€		€
T 10	25	PT10T-2	2,27	PT10T-5	1,98	PT10T-50	1,89
T 15	25	PT15T-2	2,27	PT15T-5	1,98	PT15T-50	1,89
T 20	25	PT20T-2	2,27	PT20T-5	1,98	PT20T-50	1,89
T 25	25	PT25T-2	2,27	PT25T-5	1,98	PT25T-50	1,89
T 27	25	PT27T-2	2,27	PT27T-5	1,98	PT27T-50	1,89
T 30	25	PT30T-2	2,27	PT30T-5	1,98	PT30T-50	1,89
T 40	25	PT40T-2	2,27	PT40T-5	1,98	PT40T-50	1,89

PUNTAS INTERCAMBIABLES DE ATORNILLAR

TiN



50mm
LONG.
TOTAL
(L₁)



PHILIPS



€ x Punta		2 Uds		5 Uds		50 Uds	
	L ₁ mm		€		€		€
Ph 1	50	Ph1Tx50-2	4,54	Ph1Tx50-5	4,42	Ph1Tx50-50	4,28
Ph 2	50	Ph2Tx50-2	4,54	Ph2Tx50-5	4,42	Ph2Tx50-50	4,28
Ph 3	50	Ph3Tx50-2	4,54	Ph3Tx50-5	4,42	Ph3Tx50-50	4,28

POZIDRIV



€ x Punta		2 Uds		5 Uds		50 Uds	
	L ₁ mm		€		€		€
Pz 1	50	Pz1Tx50-2	4,54	Pz1Tx50-5	4,42	Pz1Tx50-50	4,28
Pz 2	50	Pz2Tx50-2	4,54	Pz2Tx50-5	4,42	Pz2Tx50-50	4,28
Pz 3	50	Pz3Tx50-2	4,54	Pz3Tx50-5	4,42	Pz3Tx50-50	4,28

TORX



€ x Punta		2 Uds		5 Uds		50 Uds	
	L ₁ mm		€		€		€
T 10	50	PT10Tx50-2	7,12	PT10Tx50-5	6,84	PT10Tx50-50	6,65
T 15	50	PT15Tx50-2	7,12	PT15Tx50-5	6,84	PT15Tx50-50	6,65
T 20	50	PT20Tx50-2	7,12	PT20Tx50-5	6,84	PT20Tx50-50	6,65
T 25	50	PT25Tx50-2	7,12	PT25Tx50-5	6,84	PT25Tx50-50	6,65
T 27	50	PT27Tx50-2	7,12	PT27Tx50-5	6,84	PT27Tx50-50	6,65
T 30	50	PT30Tx50-2	7,12	PT30Tx50-5	6,84	PT30Tx50-50	6,65
T 40	50	PT40Tx50-2	7,12	PT40Tx50-5	6,84	PT40Tx50-50	6,65

PUNTAS INTERCAMBIALES DE ATORNILLAR

Puntas de atornillar

Roso



25mm
LONG.
TOTAL
(L₁)



PHILIPS



€ x Punta		2 Uds		5 Uds		50 Uds	
	L ₁ mm		€		€		€
Ph 1	25	Ph1D-2	3,78	Ph1D-5	3,45	Ph1D-50	3,38
Ph 2	25	Ph2D-2	3,78	Ph2D-5	3,45	Ph2D-50	3,38
Ph 3	25	Ph3D-2	3,78	Ph3D-5	3,45	Ph3D-50	3,38

POZIDRIV



€ x Punta		2 Uds		5 Uds		50 Uds	
	L ₁ mm		€		€		€
Pz 1	25	Pz1D-2	3,78	Pz1D-5	3,45	Pz1D-50	3,38
Pz 2	25	Pz2D-2	3,78	Pz2D-5	3,45	Pz2D-50	3,38
Pz 3	25	Pz3D-2	3,78	Pz3D-5	3,45	Pz3D-50	3,38

RANURA



€ x Punta		2 Uds		5 Uds		50 Uds	
	L ₁ mm		€		€		€
0,6X4,5	25	P0,6X4,5D-2	4,69	P0,6X4,5D-5	4,59	P0,6X4,5D-50	4,45
0,8X5,5	25	P0,8X5,5D-2	4,69	P0,8X5,5D-5	4,59	P0,8X5,5D-50	4,45
1X5,5	25	P1X5,5D-2	4,69	P1X5,5D-5	4,59	P1X5,5D-50	4,45
1,2X6,5	25	P1,2X6,5D-2	4,69	P1,2X6,5D-5	4,59	P1,2X6,5D-50	4,45

TORX



€ x Punta		2 Uds		5 Uds		50 Uds	
	L ₁ mm		€		€		€
T 10	25	PT10D-2	6,38	PT10D-5	5,92	PT10D-50	5,61
T 15	25	PT15D-2	6,38	PT15D-5	5,92	PT15D-50	5,61
T 20	25	PT20D-2	6,38	PT20D-5	5,92	PT20D-50	5,61
T 25	25	PT25D-2	6,38	PT25D-5	5,92	PT25D-50	5,61
T 27	25	PT27D-2	6,38	PT27D-5	5,92	PT27D-50	5,61
T 30	25	PT30D-2	6,38	PT30D-5	5,92	PT30D-50	5,61
T 40	25	PT40D-2	6,38	PT40D-5	5,92	PT40D-50	5,61

PORTAPUNTAS MAGNÉTICOS

PORTAPUNTAS MAGNÉTICOS

	L ₁ mm	TIPO DE MANGO	€
PMGx51	51	MAGNÉTICO SIN ANILLO	4,83
PMGx58	58	MAGNÉTICO SIN ANILLO	4,96
PMGx74	74	MAGNÉTICO CON ANILLO	11,00
PMGx100	100	MAGNÉTICO CON ANILLO	12,70
PMGx200	200	MAGNÉTICO CON ANILLO	20,34
PMGx250	250	MAGNÉTICO CON ANILLO	24,32
PMGSDSx78	78	SDS PLUS	21,49
PBERx74	74	BERILIO	44,61
PDESSx70	70	5/16" DESSOUTTER	27,49
P5,5x72	72	5.5mm Bosch	34,10
P7x74	74	7mm Fein	29,86



Ref. **PMGSDSx78**



Ref. **PMGX74**



Ref. **PMGX100**

PORTAPUNTAS MAGNÉTICO CON CAMBIO RÁPIDO (APTO PARA PUNTAS DE 1/4" CON CUELLO)

	L ₁ mm	TIPO DE MANGO	€
PCRx60 *	60	Cambio rápido 1/4" Apto para puntas de 1/4" con cuello	13,90
PCRx74 *	74	Cambio rápido 1/4" Apto para puntas de 1/4" con cuello	14,33
PCRSDSx80	80	SDS PLUS	28,19
PCRDESSx70	70	Cambio dessoutter	38,05
PCR5,5x72	72	Cambio 5.5mm Bosch	38,05
PCR7x74	74	Cambio Fein 7mm	38,05



Ref. **PCRSDSx80**



Ref. **PCRx60**



PORTAPUNTAS MAGNÉTICO CON ANILLO MAGNÉTICO FRONTAL ADICIONAL

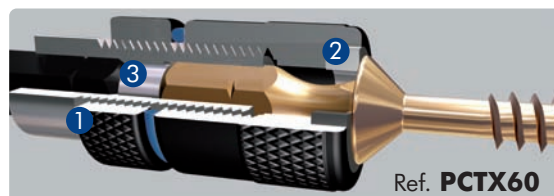
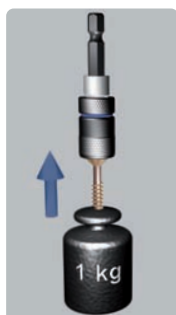

Ref. **PCTX60**

1. Tope regulable.
2. Anillo magnético frontal para sujeción de tornillo.
3. Anillo magnético para sujeción de punta.



Ref. **PCTX60**

	L ₁ mm	TIPO DE MANGO	€
PCTX60	60	Portapuntas con tope regulable	13,10
PCRTX60	60	Portapuntas cambio rápido	15,03

LLAVES DE IMPACTO STANDARD



50 mm
LONG.
TOTAL



VASO HEXAGONAL MAGNÉTICO



€ x Vaso			2 Uds
	mm	pulgadas	€
PLIHX5-2	5,0		7,09
PLIHX5,5-2	5,5		7,09
PLIHX6-2	6,0		7,09
PLIHX1/4-2		1/4"	6,78
PLIHX7-2	7,0		6,78
PLIHX8-2	8,0		6,78
PLIHX5/16-2		5/16"	6,78
PLIHX10-2	10,0		7,06
PLIHX11-2	11,0		7,96
PLIHX12-2	12,0		7,96
PLIHX13-2	13,0		7,96
PLIHX3/8-2		3/8"	7,96

ESTUCHES DE 7 PIEZAS DE LLAVES DE IMPACTO STANDARD



REFERENCIA	EPLL
Nº LLAVES	7
CONTENIDO	HX1/4 - HX7 - HX8 - HX3/8 HX10 - HX12 - HX13
P.V.P. €	49,84

DESTORNILLADOR DE CARRACA CON ALMACÉN DE PUNTAS Y EXPOSITOR PARA DESTORNILLADORES



1. Alta calidad y rendimiento
2. Giro a derechas y a izquierdas
3. Caña telescópica ajustable en longitud
4. Fabricado en acero y plástico de alta resistencia

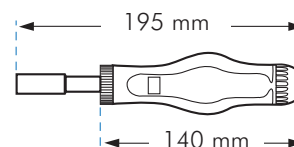
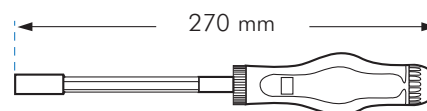

DTRC

Contenido del destornillador

- ⊕ PH1 - PH2
- ⊕ PZ1 - PZ2
- ★ T15 - T20 - T25 - T30

26,75 €

EXDTRC

Expositor con 12 Destornilladores

Ref. **DTRC**





321,00 €



ESTUCHES DE PUNTAS INTERCAMBIABLES DE ATORNILLAR

ESTUCHES DE 7 PIEZAS CALIDAD PLUS, TiN Y DiATiN







	REFERENCIA Nº PUNTAS CONTENIDO	EPT1 7 + PH1 - PH2 + PZ1 - PZ2 - 0,8x5,5 - 1,2x6,5 1 Portapuntas PMG	EPT2 7 T10 - T15 * T20 - T25 T30 - T40 1 Portapuntas PMG	EPT3 7 + PH1 - PH2 - PH3 + PZ1 - PZ2 - PZ3 1 Portapuntas PMG
	 P.V.P. €	10,80	14,57	12,95
	REFERENCIA Nº PUNTAS CONTENIDO	EPTT1 7 + PH1 - PH2 + PZ1 - PZ2 - 0,8x5,5 - 1,2x6,5 1 Portapuntas PMG	EPTT2 7 T10 - T15 * T20 - T25 T30 - T40 1 Portapuntas PMG	EPTT3 7 + PH1 - PH2 - PH3 + PZ1 - PZ2 - PZ3 1 Portapuntas PMG
	 P.V.P. €	30,66	35,54	29,56
	REFERENCIA Nº PUNTAS CONTENIDO	EPTD1 7 + PH1 - PH2 + PZ1 - PZ2 - 0,8x5,5 - 1,2x6,5 1 Portapuntas PMG	EPTD2 7 T10 - T15 * T20 - T25 T30 - T40 1 Portapuntas PMG	EPTD3 7 + PH1 - PH2 - PH3 + PZ1 - PZ2 - PZ3 1 Portapuntas PMG
	 P.V.P. €	44,68	50,19	42,42

Ref. **EPT1**

Ref. **EPTT1**

Ref. **EPTD1**

ESTUCHES DE 12 PIEZAS CALIDAD PLUS, TiN Y DiATiN

	REFERENCIA Nº PUNTAS CONTENIDO	EPT4 12 + PH1 - PH2(2) - PH3 + PZ1 - PZ2(2) - PZ3 - 0,6x4,5 - 0,8x5,5 - 1,2x6,5 1 Portapuntas PMG	EPT5 12 T10 - T15(2) * T20(2) - T25(2) T27 - T30(2) - T40 1 Portapuntas PMG
	 P.V.P. €	14,49	19,90
	REFERENCIA Nº PUNTAS CONTENIDO	EPTT4 12 + PH1 - PH2(2) - PH3 + PZ1 - PZ2(2) - PZ3 - 0,6x4,5 - 0,8x5,5 - 1,2x6,5 1 Portapuntas PCT	EPTT5 12 T10 - T15(2) * T20(2) - T25(2) T27 - T30(2) - T40 1 Portapuntas PCT
	 P.V.P. €	38,59	45,41
	REFERENCIA Nº PUNTAS CONTENIDO	EPTD4 12 + PH1 - PH2(2) - PH3 + PZ1 - PZ2(2) - PZ3 - 0,6x4,5 - 0,8x5,5 - 1,2x6,5 1 Portapuntas PCR	EPTD5 12 T10 - T15(2) * T20(2) - T25(2) T27 - T30(2) - T40 1 Portapuntas PCR
	 P.V.P. €	60,11	69,93

Ref. **EPT4**

Ref. **EPTT4**

Ref. **EPTD4**

ESTUCHES DE PUNTAS INTERCAMBIABLES DE ATORNILLAR

ESTUCHES DE 31 PIEZAS CALIDAD PLUS, TiN Y DiATiN

Ref. **EPT6**



REFERENCIA	EPT6	
Nº PUNTAS	31	
CONTENIDO	<div style="display: flex; justify-content: space-between;"> <div style="width: 45%;"> <p>⊕ PH1(3) - PH2(3) - PH3(3)</p> <p>⊕ PZ1(3) - PZ2(3) - PZ3(3)</p> <p>⊖ 0,6x4,5 - 0,8x5,5 - 1,2x6,5</p> </div> <div style="width: 45%;"> <p>⊛ T10 - T15 - T20 - T25 - T30 - T40</p> <p>○ H3 - H4 - H5</p> <p>1 Portapuntas PMG</p> </div> </div>	
P.V.P. €	41,42	
REFERENCIA	EPTT6	
Nº PUNTAS	31	
CONTENIDO	<div style="display: flex; justify-content: space-between;"> <div style="width: 45%;"> <p>⊕ PH1(3) - PH2(3) - PH3(3)</p> <p>⊕ PZ1(3) - PZ2(3) - PZ3(3)</p> <p>⊖ 0,6x4,5 - 0,8x5,5 - 1,2x6,5</p> </div> <div style="width: 45%;"> <p>⊛ T10 - T15 - T20 - T25 - T30 - T40</p> <p>○ H3 - H4 - H5</p> <p>1 Portapuntas PCT</p> </div> </div>	
P.V.P. €	87,89	
REFERENCIA	EPTD6	
Nº PUNTAS	31	
CONTENIDO	<div style="display: flex; justify-content: space-between;"> <div style="width: 45%;"> <p>⊕ PH1(3) - PH2(3) - PH3(3)</p> <p>⊕ PZ1(3) - PZ2(3) - PZ3(3)</p> <p>⊖ 0,6x4,5 - 0,8x5,5 - 1,2x6,5</p> </div> <div style="width: 45%;"> <p>⊛ T10 - T15 - T20 - T25 - T30 - T40</p> <p>○ H3 - H4 - H5</p> <p>1 Portapuntas PCR</p> </div> </div>	
P.V.P. €	149,10	

ESTUCHES DE 36 PIEZAS CALIDAD PLUS Y TiN



Ref. **EPT7**



Ref. **EPTT7**

REFERENCIA	EPT7	
Nº PUNTAS	36	
CONTENIDO	<div style="display: flex; justify-content: space-between;"> <div style="width: 45%;"> <p>⊕ PH1(3) - PH2(3) - PH3(3)</p> <p>⊕ PZ1(3) - PZ2(3) - PZ3(3)</p> <p>⊖ 0,5 x 4 - 0,6 x 4,5 - 0,8 x 5 - 0,8 x 5,5 - 1 x 6 - 1,2 x 6,5 - 1,2 x 8</p> </div> <div style="width: 45%;"> <p>⊛ T10 - T15 - T20 - T25 - T27 - T30 - T40</p> <p>○ H2 - H2,5 - H3 - H4 - H5 - H6 - H8</p> <p>1 Portapuntas PMG</p> </div> </div>	
P.V.P. €	52,45	
REFERENCIA	EPTT7	
Nº PUNTAS	36	
CONTENIDO	<div style="display: flex; justify-content: space-between;"> <div style="width: 45%;"> <p>⊕ PH1(3) - PH2(3) - PH3(3)</p> <p>⊕ PZ1(3) - PZ2(3) - PZ3(3)</p> <p>⊖ 0,5 x 4 - 0,6 x 4,5 - 0,8 x 5 - 0,8 x 5,5 - 1 x 6 - 1,2 x 6,5 - 1,2 x 8</p> </div> <div style="width: 45%;"> <p>⊛ T10 - T15 - T20 - T25 - T27 - T30 - T40</p> <p>○ H2 - H2,5 - H3 - H4 - H5 - H6 - H8</p> <p>1 Portapuntas PCT</p> </div> </div>	
P.V.P. €	107,63	

ESTUCHES DE PUNTAS INTERCAMBIABLES DE ATORNILLAR

ESTUCHES DE 45 Y 80 PIEZAS CALIDAD *Plus*



Ref. **EPT45**



Ref. **EPT80**



Puntas de atornillar

Rosa

REFERENCIA	EPT45
Nº PUNTAS	45
CONTENIDO	<ul style="list-style-type: none"> ⊕ PH1 (2) - PH2(2) - PH3(2) ⊕ PZ1 (2) - PZ2(2) - PZ3(2) ⊖ 0,5x3 - 0,6x4,5 - 0,8x5,5(2) - 1,2x6,5 - 1,6x8 ○ H2,5 - H3 - H4 - H5 - H6 - H7 ⊛ T10 - T15 - T20 - T25 - T30 - T40 ⬡ Llaves de vasos Hexagonales (mm): 5 - 6 - 7 - 8 - 9 - 10 - 11 - 12 - 13 - 14 ⬡ 1 Adaptador de Vasos ⬡ 1 Adaptador de Puntas ⬡ 1 Portapuntas Magnético PCR ⬡ 1 Llave de Carraca de 72 dientes 1 Destornillador
P.V.P. €	131,25

REFERENCIA	EPT80
Nº PUNTAS	80
CONTENIDO	<ul style="list-style-type: none"> ⊕ PH0 - PH1 - PH2(4) - PH3(2) ⊕ PZ1 - PZ2(4) - PZ3(2) ⊖ 0,5x3 - 0,6x4,5 - 0,8x5,5(2) - 1,2x6,5 - 1,6x8 ○ H2 - H2,5 - H3 - H4 - H5 - H6 - H7 - H8 ⊚ TW1 - TW2 - TW3 - TW4 - TW5 ⊛ TQ5 - TQ6 - TQ8 - TQ10 ⊛ T5 - T6 - T7 - T8 - T9 - T10 - T15 - T20(2) - T25(2) - T27 - T30 - T40 ⊛ TS10 - TS15 - TS20 - TS25 - TS30 - TS40 □ C0 - C1 - C2 - C3 ⊖ SP4 - SP6 - SP8 - SP10 ⊖ HS3 - HS4 - HS5 - HS6 ⬡ 1 Portapuntas PCR 1 Destornillador ⊕ PH1 - PH2 ⊕ PZ1 - PZ2 ⊛ T15 - T20 - T25 - T30
P.V.P. €	156,45

EXPOSITORES DE SOBREMESA PARA ESTUCHES DE 36 Y 80 PIEZAS



EXEPT7

10 Estuches de 36 piezas



Ref. **EPT7**

524,48 €



EXEPT7

10 Estuches de 36 piezas



Ref. **EPT7**

1.076,25 €



EXEPT80

5 Estuches de 80 piezas



Ref. **EPT80**

782,25 €

EXTRACTORES DE MÁQUINA PARA TORNILLOS ROTOS

MICRO GRABIT



	EP
	€
EP451C M3	36,88
EP452C M4	36,88
EP453C M5	36,88
EP454C M6	36,88

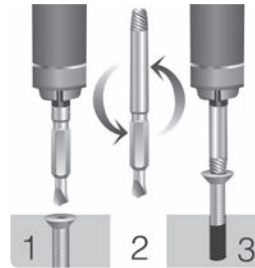

1. Taladrar el tornillo
2. Dar la vuelta.
3. Extraer



PRO GRABIT CON CUERPO HEXAGONAL 1/4"



	EP
	€
EP8401C M5	29,26
EP8402C M6	34,56
EP8403C M8	34,56
EP8404C M10	36,28

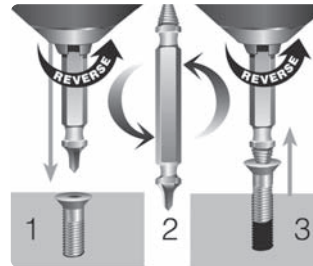

1. Taladrar el tornillo
2. Dar la vuelta.
3. Extraer



DRILL-OUT EXTRACTOR DE TORNILLOS ROTOS CON BROCA GUÍA (M6-M12)



	EP
	€
EP205C M6	35,77
EP312C M8	43,33
EP375C M10	43,33
EP500C M12	48,79

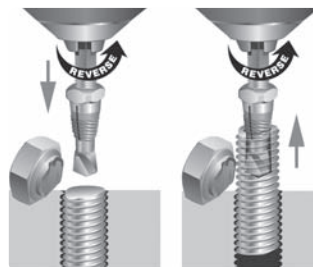

X-OUT EXTRACTOR DE TORNILLOS ROTOS CON MANGO HEXAGONAL (M3-M5)



	EP
	€
EP3701C M3	29,26
EP3702C M4	29,26
EP3703C M5	32,52

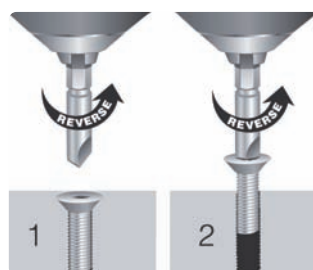

ESTUCHES DE EXTRACTORES DE MÁQUINA PARA TORNILLOS ROTOS

MICROGRABIT



REFERENCIA	EP450C
Nº PIEZAS	4
CONTENIDO	M3-M4-M5-M6
P.V.P. €	151,32

PROGRABIT



REFERENCIA	EP8420C
Nº PIEZAS	2
CONTENIDO	M5-M6
P.V.P. €	61,86



REFERENCIA	EP8430C
Nº PIEZAS	3
CONTENIDO	M5-M6-M8
P.V.P. €	90,21



REFERENCIA	EP8440C
Nº PIEZAS	4
CONTENIDO	M5-M6-M8-M10
P.V.P. €	123,81

DRILL-OUT



REFERENCIA	EP401C
Nº PIEZAS	4
CONTENIDO	M6-M8-M10-M12
P.V.P. €	178,00

MIXTOS



REFERENCIA	EP701C
Nº PIEZAS	7
CONTENIDO	MICRO GRABIT (M3-M6) DRILL OUT (M8-M12)
P.V.P. €	249,20



REFERENCIA	EP100C
Nº PIEZAS	10
CONTENIDO	X OUT (M3-M5) - MICRO GRABIT (M3-M6) DRILL OUT (M8-M12)
P.V.P. €	278,44

EXTRACTORES DE MANO PARA TORNILLOS ROTOS

JUEGOS DE EXTRACTORES CLÁSICOS DE TORNILLOS

Taladrar un agujero central con la broca Blue-Master recomendada; Introducir el extractor en el agujero, haciendo girar el extractor hacia la izquierda, hasta extraer el tornillo.

REFERENCIA	EX/1-5	EX/1-6	EX/1-8
Nº PIEZAS	5	6	8
CONTENIDO	M3 - M18	M3 - M24	M3 - M45
P.V.P. €	13,72	19,38	42,84



Ref. EX/1-6

EXTRACTORES SUELTOS



	Para TORNILLOS	mm	mm	L1 mm	Ø min. mm	Ø max. mm	EX €
EX/1	M3 - M6	3,2	2,5	51	1,75	3,95	1,82
EX/2	M6 - M8	4,0	3,0	60	2,20	4,80	1,82
EX/3	M8 - M11	5,1	4,5	68	3,30	6,40	2,15
EX/4	M11 - M14	6,2	6,0	76	4,75	8,40	2,67
EX/5	M14 - M18	8,6	8,0	86	6,35	11,00	3,47
EX/6	M18 - M24	12,0	11,0	95	9,50	15,00	5,87
EX/7	M24 - M33	15,9	14,0	105	12,70	19,00	15,90
EX/8	M33 - M50	20,0	21,0	111	19,00	25,00	26,04



REFERENCIA	EXTT
Nº PIEZAS	10
EXTRACTORES BROCAS PREVIAS	EX/1-EX/2-EX/3-EX/4-EX/5 Ref. BC3 Ø2,5-3-4-5-6-8
P.V.P. €	24,41

HERRAMIENTAS CON MANGO HEXAGONAL 1/4"

BROCA PARA METAL DIN 338

Ref. **BH2** **HSS**    **OX**



				BH2
	Ø mm	L ₁ x L ₂ mm		€
BH20300	3,00	61 x 33	1/4"	4,50
BH20400	4,00	75 x 43	1/4"	5,22
BH20500	5,00	86 x 52	1/4"	6,49
BH20600	6,00	93 x 57	1/4"	7,00
BH20700	7,00	109 x 69	1/4"	8,82
BH20800	8,00	117 x 75	1/4"	9,91
BH20900	9,00	125 x 81	1/4"	11,15
BH21000	10,00	133 x 87	1/4"	12,41

BROCA PARA METAL EXTRA CORTA

Ref. **BC59** **HSS-G**  Disponible con mango hexagonal con cuello bajo demanda.

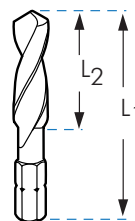

				BC59
Ø	L ₁ x L ₂ mm		€	
1,00	34 x 12	1/4"	5,37	
1,50	34 x 12	1/4"	5,37	
2,00	34 x 12	1/4"	5,37	
2,50	36 x 14	1/4"	5,37	
3,00	38 x 16	1/4"	5,37	
3,30	40 x 18	1/4"	5,37	
3,50	40 x 18	1/4"	5,37	
4,00	44 x 20	1/4"	5,37	
4,20	45 x 20	1/4"	5,37	
4,50	46 x 24	1/4"	5,37	
5,00	50 x 26	1/4"	5,37	
5,50	50 x 26	1/4"	5,86	
6,00	50 x 26	1/4"	5,86	
6,50	50 x 30	1/4"	5,86	
6,80	50 x 30	1/4"	5,86	
7,00	50 x 30	1/4"	5,86	
7,50	51 x 32	1/4"	6,63	
8,00	51 x 32	1/4"	6,63	
8,50	53 x 33	1/4"	6,63	
9,00	53 x 33	1/4"	8,01	
9,50	54 x 38	1/4"	8,01	
10,00	54 x 38	1/4"	8,01	
10,20	54 x 38	1/4"	8,01	

BROCAS BIDIAMETRALES

Ref. **BH36**

HSS

90°

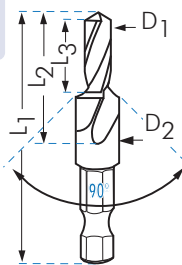
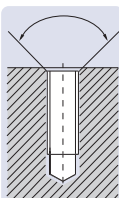



							BH36
	D ₂ mm	D ₁ mm	L ₁ x L ₂ mm	L ₃ mm		€	
BH36M2	M2	2,3	1,6	35 x 6,5	5	1/4"	30,91
BH36M3	M3	3,4	2,5	47 x 10,4	8	1/4"	33,53
BH36M4	M4	4,5	3,3	53 x 14,3	11	1/4"	33,46
BH36M5	M5	5,5	4,2	59 x 16,9	13	1/4"	39,46
BH36M6	M6	6,6	5,0	59 x 16,9	16	1/4"	42,72
BH36M8	M8	9,0	6,8	70 x 26,0	20	1/4"	55,09
BH36M10	M10	11,0	8,5	70 x 26,0	24	1/4"	68,16

Ref. **BH34**

HSS

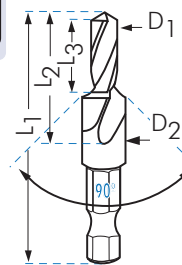
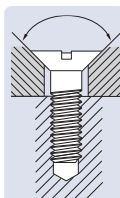
90°







							BH34
	D ₂ mm	D ₁ mm	L ₁ x L ₂ mm	L ₃ mm		€	
BH34M3	M3	6,0	3,2	47 x 10,4	8	1/4"	37,82
BH34M4	M4	8,0	4,3	53 x 14,3	11	1/4"	41,18
BH34M5	M5	10,0	5,3	59 x 16,9	13	1/4"	49,73
BH34M6	M6	12,0	6,4	59 x 16,9	16	1/4"	59,05
BH34M8	M8	16,0	8,4	70 x 26,0	20	1/4"	69,79
BH34M10	M10	20,0	10,5	70 x 26,0	24	1/4"	83,09

HERRAMIENTAS CON MANGO HEXAGONAL 1/4"

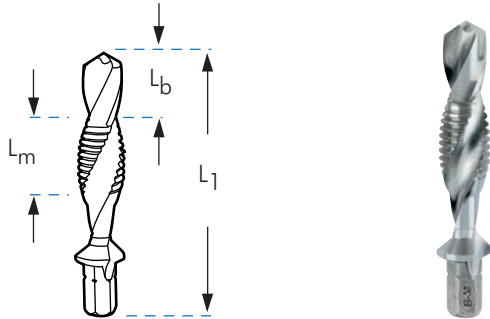
BROCA-MACHOS AVELLANADORES

Ref. **MAHM** **HSS-G**  Disponible con mango hexagonal con cuello bajo demanda.





 	$L_1 \times L_b \times L_m$ mm		MAHM	€
M 3 x 0,50	36 x 5 x 6	1/4"		15,30
M 4 x 0,70	39 x 6 x 7	1/4"		15,30
M 5 x 0,80	41 x 8 x 8	1/4"		15,30
M 6 x 1,00	44 x 8 x 10	1/4"		15,30
M 8 x 1,25	50 x 10 x 11	1/4"		21,16
M 10 x 1,50	59 x 11 x 11	1/4"		25,52

MACHO HSS-G

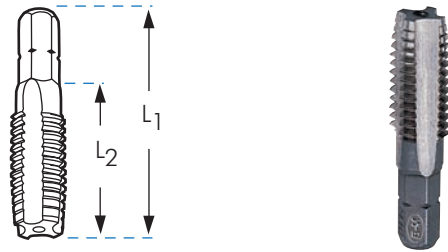
Ref. **M** **HSS-G**  Disponible con mango hexagonal con cuello bajo demanda.



	$L_1 \times L_2$ mm		M	€
M 3 x 0,50	33 x 11	1/4"		5,70
M 4 x 0,70	35 x 12	1/4"		5,70
M 5 x 0,80	36 x 15	1/4"		7,26
M 6 x 1,00	39 x 18	1/4"		7,26
M 8 x 1,25	40 x 19	1/4"		10,06
M 10 x 1,50	41 x 21	1/4"		12,42

AVELLANADORES DE 3 CORTES

Ref. **AV22** **HSS-G**  Disponible con mango hexagonal con cuello bajo demanda.

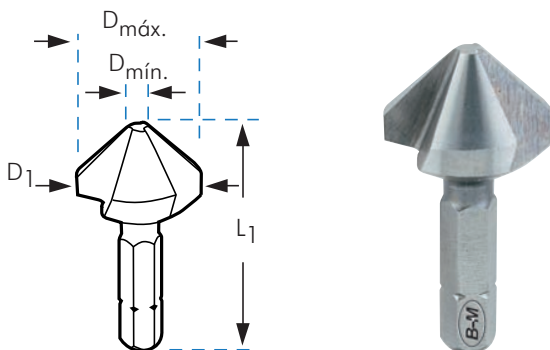

D_1 mm	L_1 mm	$D_{mín.} - D_{máx.}$ mm		AV22	€
6,30	31	1,50 - 5,8	1/4"		14,51
8,30	31	2,00 - 7,8	1/4"		14,51
10,40	34	2,50 - 10,0	1/4"		15,55
12,40	35	2,80 - 12,0	1/4"		16,58
16,50	40	3,20 - 16,0	1/4"		17,76
20,50	41	3,50 - 20,0	1/4"		21,32

AVELLANADORES PARA DESBARBAR

Ref. **AV1...CR** **HSS**  

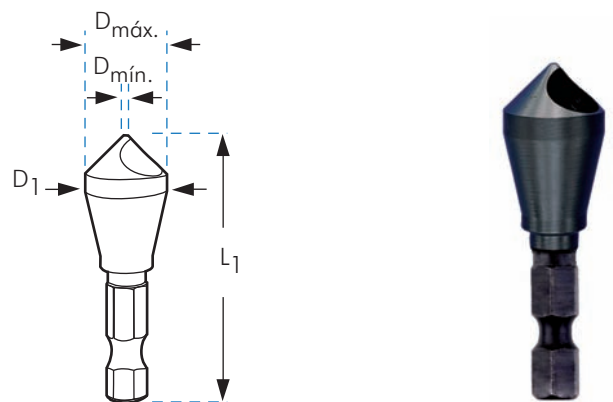

D_1 mm	L_1 mm	$D_{mín.} - D_{máx.}$ mm		AV1...CR	€
AV101CR	10,00	45	2,0 - 5,0	1/4"	14,52
AV102CR	14,00	48	5,0 - 10,0	1/4"	18,14
AV103CR	20,00	65	10,0 - 15,0	1/4"	32,50
AV104CR	27,00	85	15,0 - 20,0	1/4"	58,05

Disponible broca avellanadora helicoidal y broca escalonada con mango hexagonal 1/4". Consultar páginas 107 y 110

HERRAMIENTAS CON MANGO HEXAGONAL 1/4"

BROCA PARA PARED

Ref. **BWH**

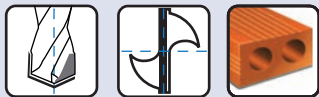

	BWH			
	Ø mm	L ₁ x L ₂ mm		€
BWH03	3	70 x 30	1/4"	2,21
BWH04	4	70 x 30	1/4"	2,45
BWH05	5	85 x 45	1/4"	2,76
BWH06	6	100 x 50	1/4"	3,08
BWH07	7	100 x 50	1/4"	3,47
BWH08	8	120 x 70	1/4"	4,18
BWH09	9	120 x 70	1/4"	4,81
BWH10	10	120 x 70	1/4"	5,60
BWH11	11	150 x 80	1/4"	6,70
BWH12	12	150 x 80	1/4"	7,88
BWH13	13	150 x 80	1/4"	9,06
BWH14	14	150 x 80	1/4"	10,55

BROCA PARA MADERA

Ref. **BMH**



	BMH			
	Ø mm	L ₁ x L ₂ mm		€
BMH03	3	59 x 35	1/4"	1,34
BMH04	4	74 x 41	1/4"	1,42
BMH05	5	82 x 55	1/4"	1,40
BMH06	6	88 x 58	1/4"	1,89
BMH07	7	110 x 70	1/4"	2,14
BMH08	8	110 x 70	1/4"	2,23
BMH09	9	110 x 70	1/4"	2,32
BMH10	10	115 x 75	1/4"	2,57
BMH11	11	135 x 85	1/4"	3,00
BMH12	12	135 x 85	1/4"	3,52
BMH13	13	135 x 90	1/4"	5,51
BMH14	14	145 x 95	1/4"	6,86



REFERENCIA	BWH9318	BWH9327	BWH9319	BMH9335	BMH9333
Nº BROCAS	5	5	8	5	8
APLICACIÓN	PARED	PARED	PARED	MADERA	MADERA
CONTENIDO	Ø 3-4-5-6-8 mm	Ø 4-5-6-8-10 mm	Ø 3-4-5-6-7-8-9-10 mm	Ø 3-4-5-6-8 mm	Ø 3-4-5-6-7-8-9-10 mm
P.V.P. €	19,53	24,04	26,98	11,55	15,23

ESTUCHES DE HERRAMIENTAS CON MANGO HEXAGONAL 1/4"



Ref. **EB**



Ref. **EMBP**

CONTENIDO

P.V.P. €

EM	M3 - M4 - M5 - M6 M8 - M10	-	-	-	49,66
EMBP	M3 - M4 - M5 - M6 M8 - M10	Ø 2,50 - 3,30 - 4,20 5 - 6,80 - 8,50	-	-	74,94
EBM	-	-	M3 - M4 - M5 - M6 M8 - M10	-	106,47
EA	-	-	-	Ø 6,30 - 8,30 - 10,40 12,40 - 16,50 - 20,50	100,23
EB	-	Ø 1 - 10 mm x 0,50	-	-	89,08